

MAXinBOX Hospitality v2

**Two/Four-Pipe Fan Coil Controller with
Two Digital Outputs and 6 Analogue/Digital Inputs**

ZCLHP126V2

Application program version: [1.0]

User manual edition: [1.0]_a

www.zennio.com

CONTENTS

Contents	2
1 Introduction	3
1.1 MAXinBOX Hospitality v2	3
1.2 Installation.....	5
1.3 Start-Up and Power Loss	6
1.4 Status Indicators.....	7
1.4.1 Binary and Shutter Outputs	7
1.4.2 Fan Coil Control Outputs (Valve / Fan)	7
2 Configuration.....	8
2.1 General.....	8
2.2 Inputs	10
2.2.1 Binary Input.....	10
2.2.2 Temperature Probe.....	10
2.2.3 Motion Detector	10
2.3 Outputs.....	11
2.4 Fan Coil.....	12
2.5 Logic Functions.....	13
2.6 Hospitality Thermostat.....	14
2.7 Master Light	15
2.8 Scene Temporisation.....	18
2.9 Manual Control	20
ANNEX I. Communication Objects.....	25

1 INTRODUCTION

1.1 MAXinBOX Hospitality v2

MAXinBOX Hospitality v2 from Zennio is a versatile KNX multi-function actuator destined to cover the climate control needs in KNX environments with integrated **fan coil units** where both the fan speed and the opening of the water pipe valves are controlled by relays.

At a glance, the most outstanding features of MAXinBOX Hospitality v2 are:

- **2 multi-purpose relay outputs**, configurable as:

- Up to two binary outputs.
- Up to one shutter channel.

Note: *if a four-pipe fan coil with a three-point valve is configured, these two outputs are used to control the valve.*

- **2 relay outputs to control one three-point valve or up to two on-off valves.** One of these outputs can also be configured as an additional **multi-purpose relay output** (in this case, for non-capacitive loads) in case it is not necessary for the fan coil control.

- **2 independent Hospitality Thermostats.**

- **3 relay outputs to control up to three fan levels.**

- **6 multi-purpose inputs**, each of them configurable as:

- Temperature probe,
- Binary input (i.e., pushbuttons, switches, sensors),
- Motion detector.

- **10 customisable, multi-operation logic functions.**

- **Master light control** for an easy, out-of-the-box control of a set of luminaires (or functionally equivalent devices) one of which acts as a general lamp and the others as secondary lamps.

- **Scene-triggered action control**, with an optional delay in the execution.

- **Manual operation / supervision** of the relay outputs through the on-board pushbuttons and LEDs.
- **Heartbeat** or periodical “still-alive” notification.
- **Relay Switches Counter**.

1.2 INSTALLATION

MAXinBOX Hospitality v2 connects to the KNX bus through the on-board KNX connector.

Once the device is provided with power from the KNX bus, both the individual address and the associated application program may be downloaded.

This device does not need any additional external power since it is entirely powered through the KNX bus.

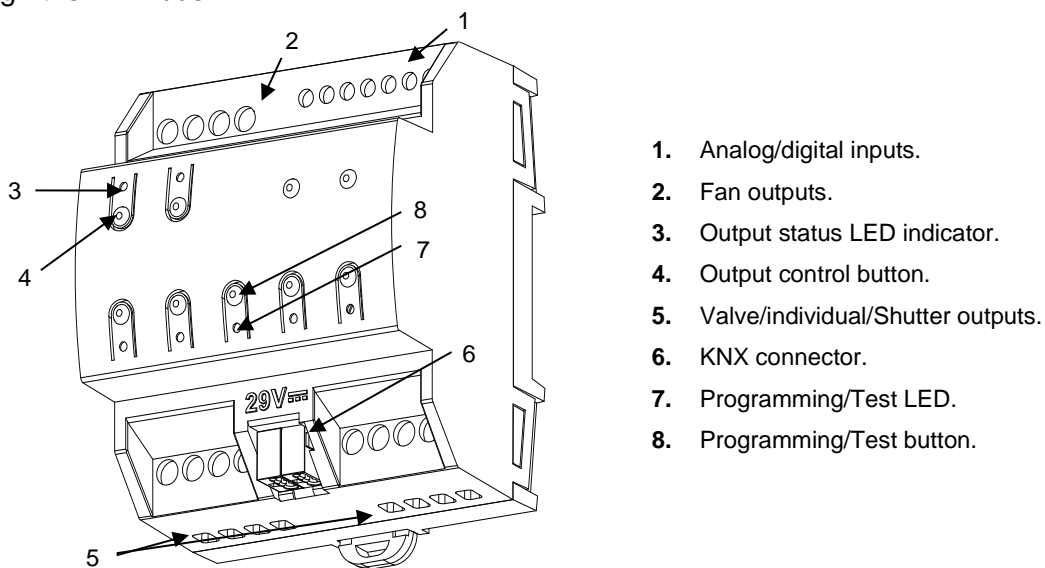

Figure 1 MAXinBOX Hospitality v2 Elements.

The main elements of the device are described next.

- **Prog./Test Pushbutton (9):** a short press on this button sets the device into the programming mode, making the associated LED (8) light in red.

Note: if this button is held while plugging the device into the KNX bus, the device will enter into **safe mode**. In such case, the LED will blink in red every 0.5 seconds.

- **Outputs (2, 5 and 6):** output ports for the insertion of the stripped cables of the systems being controlled by the actuator (see sections 2.3 and 2.4). Please secure the connection by means of the on-board screws.

- **Inputs (1):** input ports for the insertion of the stripped cables of external elements such as switches / motion detectors / temperature probes, etc. One of the two cables of each element needs to be connected to one of the slots labelled “1” to “6”, while the other cable should be connected to the slot labelled as “C”. Note that all the external input devices share the “C” slot for one of the two cables. Please secure the connection by means of the on-board screws.

For detailed information about the technical features of the device and for safety instructions or about the installation process, please refer to the corresponding **Datasheet**, bundled with the original package of the device and also available at www.zennio.com.

1.3 START-UP AND POWER LOSS

During the device start-up, the Prog./Test LED will blink **in blue colour** for a few seconds before MAXinBOX Hospitality v2 is ready. External orders will not be executed during this time, but afterwards.

Depending on the configuration, **some specific actions** will also be performed during the start-up. For example, the integrator can set whether the output channels should switch to a particular state and whether the device should send certain objects to the bus after the power recovery. Please consult the next sections of this document for further details.

On the other hand, when **a bus power failure** takes place, MAXinBOX Hospitality v2 will interrupt any pending actions, and will save its state so it can be recovered once the power supply is restored. In addition, the individual outputs will switch to the specific state configured in parameters.

1.4 STATUS INDICATORS

Each of the outputs of MAXinBOX Hospitality v2 incorporates a light indicator that reflects its current state.

1.4.1 BINARY AND SHUTTER OUTPUTS

If an output is configured as binary, the LED indicator will only be on while the relay remains closed; otherwise it remains off.

If configured as a shutter channel, the LED indicator will only remain on while the shutter is in motion.

Please refer to section 2.3 for details about the relay outputs.

1.4.2 FAN COIL CONTROL OUTPUTS (VALVE / FAN)

Regarding the **valve control outputs**, the LED indicator of each output will behave analogously as the LEDs of the binary outputs: it will remain off while the corresponding valve is closed and on while the corresponding valve is open.

Regarding the **fan control outputs**, the two LED indicators provide information about the current fan speed level:

- Fan switched off: both LEDs off.
- Fan at speed level 1: both LEDs blinking every 1 second.
- Fan at speed level 2: both LEDs blinking every 0.5 seconds.
- Fan at speed level 3: both LEDs steadily on.

In case **less than three different speed levels** have been parameterised, the LEDs will stay steadily on while the fan is at the maximum level (e.g., level 2), and as described above for the lower levels (e.g., levels 1 and off).

Please refer to section 2.4 for details about the fan coil control outputs.

2 CONFIGURATION

2.1 GENERAL

After importing the corresponding database in ETS and adding the device into the topology of the desired project, the configuration process begins by entering the Parameters tab of the device.

ETS PARAMETERISATION

From the “General” tab it is possible to mark/unmark the appropriate checkboxes to enable the required functionality. The only one active by default is “**Manual Control**” (see section 2.9), thus the corresponding tab will also be available from the beginning in the tab tree on the left.

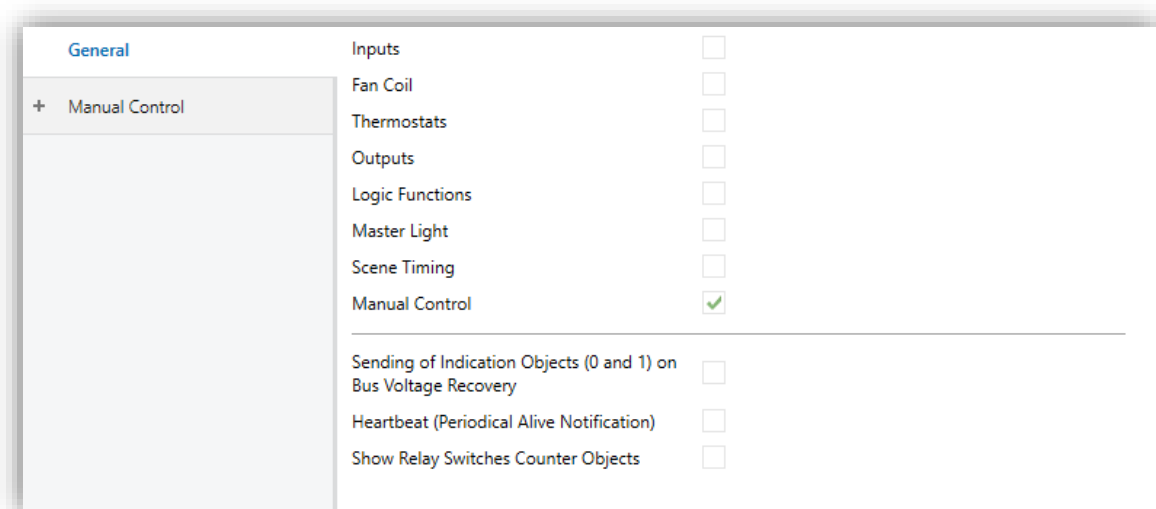
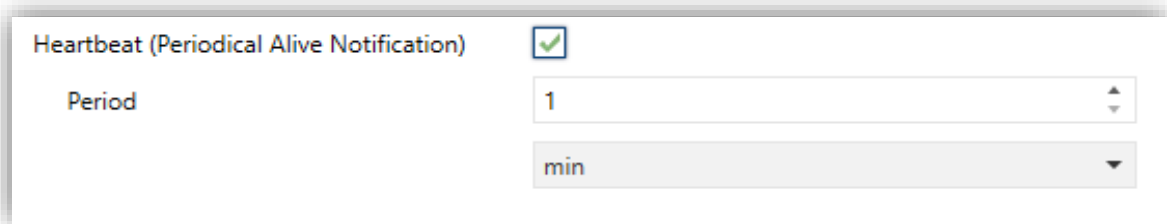

Figure 2 General screen.

- Once activated, **Inputs, Fan Coil, Thermostats, Binary Outputs, Logical Functions, Scene Timing, Manual Control** (enabled by default) and **Master Light** bring additional tabs to the menu on the left. These functions and their parameters will be explained in later sections of this document.
- **Sending of Indication Objects (0 and 1) on Bus Voltage Recovery:** this parameter lets the integrator activate two new communication objects (“**Reset 0**” and “**Reset 1**”), which will be sent to the KNX bus with values “0” and “1”

respectively whenever the device begins operation (for example, after a bus power failure). It is possible to parameterise a certain **delay** to this sending (0 to 255 seconds).

- **Heartbeat (Periodical Alive Notification):** lets the integrator incorporate a one-bit object to the project (“**[Heartbeat] Object to Send ‘1’**”) that will be sent periodically with value “1” to notify that the device is still working (*still alive*).



Heartbeat (Periodical Alive Notification)

Period

Figure 3 Heartbeat (Periodical Alive Notification).

Note: *The first sending after download or bus failure takes place with a delay of up to 255 seconds, to prevent bus overload. The following sendings match the period set.*

- **Show Relay Switches Counter Objects:** enables two communication objects to keep track of the number of switches performed by each of the relays (“**[Relay X] Number of Switches**”) and the maximum number of switches carried out in a minute (“**[Relay X] Maximum Switches per Minute**”).

2.2 INPUTS

MAXinBOX Hospitality v2 incorporates **6 analogue/digital inputs**, each configurable as a:

- **Binary Input**, for the connection of a pushbutton or a switch/sensor.
- **Temperature Probe**, for the connection of a temperature sensor from Zennio.
- **Motion Detector**, to connect a motion/luminosity detector.

2.2.1 BINARY INPUT

Please refer to the “**Binary Inputs**” user manual, available under the MAXinBOX Hospitality v2 product section at www.zennio.com.

2.2.2 TEMPERATURE PROBE

Please refer to the “**Temperature Probe**” user manual, available under the MAXinBOX Hospitality v2 product section at www.zennio.com.

2.2.3 MOTION DETECTOR

It is possible to connect Zennio motion detectors to the input ports of MAXinBOX Hospitality v2. This brings the device with the possibility of monitoring motion and presence in the room, as well as the light level. Depending on the detection, different response actions can be parameterised.

Please refer to the “**Motion Detector**” user manual, available under the MAXinBOX Hospitality v2 product section at www.zennio.com, for detailed information about the functionality and the configuration of the related parameters.

2.3 OUTPUTS

MAXinBOX Hospitality v2 incorporates two relay outputs, which can be configured in parameters as individual **binary outputs** to control up to two different loads, or as a joint **shutter channel** to control shutters and blinds, with or without slats.

Moreover, in case the fan coil module remains disabled (see section 2.4) or is configured to control a two-pipe fan coil unit consisting of a sole on-off valve, it is possible to configure one of the two valve control relay outputs (V2) as a **third multi-purpose binary output**, although not valid to control capacitive loads.

PARAMETERISATION

When the Outputs function has been activated in the “General” parameter screen, the “**Outputs**” section will be available in the tree on the left, containing itself a tab named “**Configuration**”.

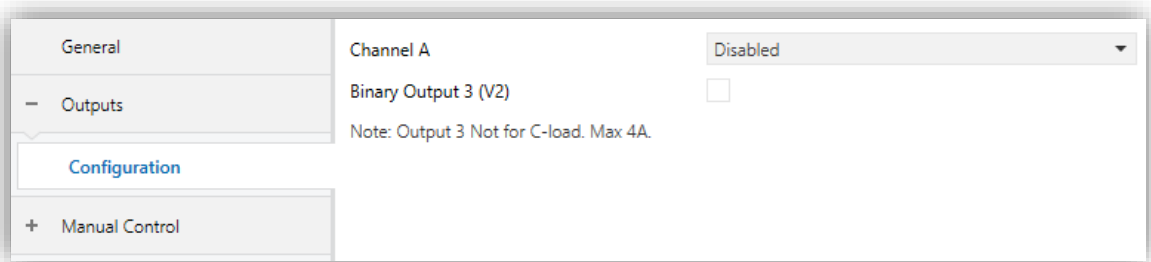

Figure 4 Outputs – Configuration.

Channel A can be configured through the drop-down list as two independent **binary outputs** or as a **shutter channel** (which makes use of both relays). **Binary output V2** will also be available for configuration once the Fancoil function has been disabled.

According to the above configuration, new entries will be incorporated into the tab tree.

For detailed information about the functionality and the configuration of the related parameters, please refer to the following specific manuals, available in the MAXinBOX Hospitality v2 product section at the Zennio homepage (www.zennio.com):

- **Individual outputs.**
- **Shutter channels.**

2.4 FAN COIL

MAXinBOX Hospitality v2 incorporates one **fan coil control module**, which will be responsible for operating the relays that open and close the water pipe valves (either one three-point valve or up to two on-off valves), and the relays that set the fan speed level. The latter can be achieved through **relay accumulation** (more relays closed means a higher fan speed) or through **relay commutation** (one specific relay will be available per level), depending on the configuration. The relays distribution for the valves control is shown in the following table for every possible parameterisation:

Number of pipes	Valve type	Output	Action
4	On / Off	Output V1	Cooling Valve
		Output V2	Heating Valve
	Three-point	Output V1	Opening Cooling Valve
		Output V2	Closing Cooling Valve
		Output 1	Opening Heating Valve
		Output 2	Closing Heating Valve
2	On / Off	Output V1	Cooling and/or Heating Valve
	Three-point	Output V1	Opening Valve for both modes
		Output V2	Closing Valve for both modes

Table 1 Actions performed by the binary outputs associated to the valve control.

For a detailed description of these functions and on their configuration, please refer to the specific manual "**Relays Fan Coil**", available under the MAXinBOX Hospitality v2 product section at www.zennio.com.

2.5 LOGIC FUNCTIONS

This module makes it possible to perform numeric and binary operations to incoming values received from the KNX bus, and to send the results through other communication objects specifically enabled for this purpose.

MAXinBOX Hospitality v2 allows enabling and fully customising up to **ten different logic functions** with their corresponding input objects, whose size can be 1 bit, 1 byte, 2 bytes or 4 bytes.

The execution of each function can depend on a configurable **condition**, which will be evaluated every time the function is **triggered** through specific, parameterisable communication objects. The result after executing the operations of the function can also be evaluated according to certain **conditions** and afterwards sent (or not) to the KNX bus, which can be done every time the function is executed, periodically or only when the result differs from the last one.

For detailed information about the functionality and the configuration of the related parameters, please refer to the specific manual “**Logic Functions**” available under the MAXinBOX Hospitality v2 product section at the www.zennio.com website.

2.6 HOSPITALITY THERMOSTAT

As described in previous sections, MAXinBOX Hospitality v2 includes two instances of the Hospitality Thermostat, which can be enabled and customized independently.

Please refer to the “**Hospitality Thermostat**” user manual, available under the MAXinBOX Hospitality v2 product section at www.zennio.com, for detailed information about the functionality and the configuration of the related parameters.

2.7 MASTER LIGHT

The Master Light function brings the option to monitor the state of up to 12 light sources (or even more, if the Master Light controls from multiple Zennio devices are linked together) or of any other elements whose state is transmitted through a binary object and, depending on those states, perform a **master order** every time a certain trigger signal (again, a binary value) is received through a specific object.

Such master order will consist in:

- A **general switch-off** order, if at least one of the up to twelve status objects is found to be on.
- A **courtesy switch-on** order, if none of the up to twelve status objects is found to be on.

Note that the above switch-off and switch-on orders are not necessarily a binary value being sent to the bus – it is up to the integrator the decision of what to send to the KNX bus in both cases: a shutter order, a thermostat setpoint or mode switch order, a constant value, a scene... Only the trigger object and the twelve status objects are required to be binary (on/off).

The most typical scenario for this Master Light control would be a hotel room with a master pushbutton next to the door. When leaving the room, the guest will have the possibility of pressing on the master pushbutton and make all the lamps turn off together. Afterwards, back on the room and with all the lamps off, pressing on the same master pushbutton will only make a particular lamp turn on (e.g., the closest lamp to the door) – this is the courtesy switch-on.

Besides, it is possible to concatenate two or more Master Light modules by means of a specific communication object which represents the general state of the light sources of each module. Thereby, it is possible to expand the number of light sources by considering the general state of one module as an additional light source for another.

ETS PARAMETERISATION

Once the Master Light function has been enabled, a specific tab will be included in the menu on the left. This new parameter screen () contains the following options:

- **Number of State Objects:** defines the number of 1-bit status objects required. The minimum (and default) value is “1”, and the maximum is “12”. These objects are called “[ML] Status Object *n*”.

In addition, the general status object (“[ML] General status”) will always be available in the project topology. It will be sent to the bus with a value of “1” whenever there is at least one of the above state objects with such value. Otherwise (i.e., if none of them has a value of “1”), it will be sent with a value of “0”.

- **Trigger Value:** sets the value (“0”, “1” or “0/1”, being the latter the default option) that will trigger, when received through “[ML] Trigger”, the master action (the general switch-off or the courtesy switch-on).

- **General Switch-Off.**

- **Delay:** defines a certain delay (once the trigger has been received) before the execution of the general switch-off. The allowed range is 0 to 255 seconds.
- **Binary Value:** if checked, object “[ML] General Switch-off: Binary Object” will be enabled, which will send one “0” whenever the general switch-off takes off.
- **Scaling:** if checked, object “[ML] General Switch-off: Scaling” will be enabled, which will send a percentage value (configurable in “Value”) whenever the general switch-off takes off.
- **Scene:** if checked, object “[ML] General Switch-off: Scene” will be enabled, which will send a scene run / save order (configurable in “Action” and “Scene Number”) whenever the general switch-off takes off
- **HVAC:** if checked, object “[ML] General Switch-off: HVAC mode” will be enabled, which will send an HVAC thermostat mode value (configurable in

“Value”, being the options “Auto”, “Comfort”, “Standby”, “Economy” and “Building Protection”) whenever the general switch-off takes off

Note: the above options are not mutually exclusive; it is possible to send values of different nature together.

● **Courtesy Switch-On:**

The parameters available here are entirely analogous to those already mentioned for General Switch-Off. However, in this case the names of the objects start with “[ML] Courtesy Switch-On (...)”. On the other hand, sending **scene save orders** is not possible for the courtesy switch-on (only orders to play scenes are allowed).

Note: object “[ML] Courtesy Switch-On: Binary Object” sends the value “1” (when the courtesy switch-on takes place), in contrast to object “[ML] General Switch-Off: Binary Object”, which sends the value “0” (during the general switch-off, as explained above).

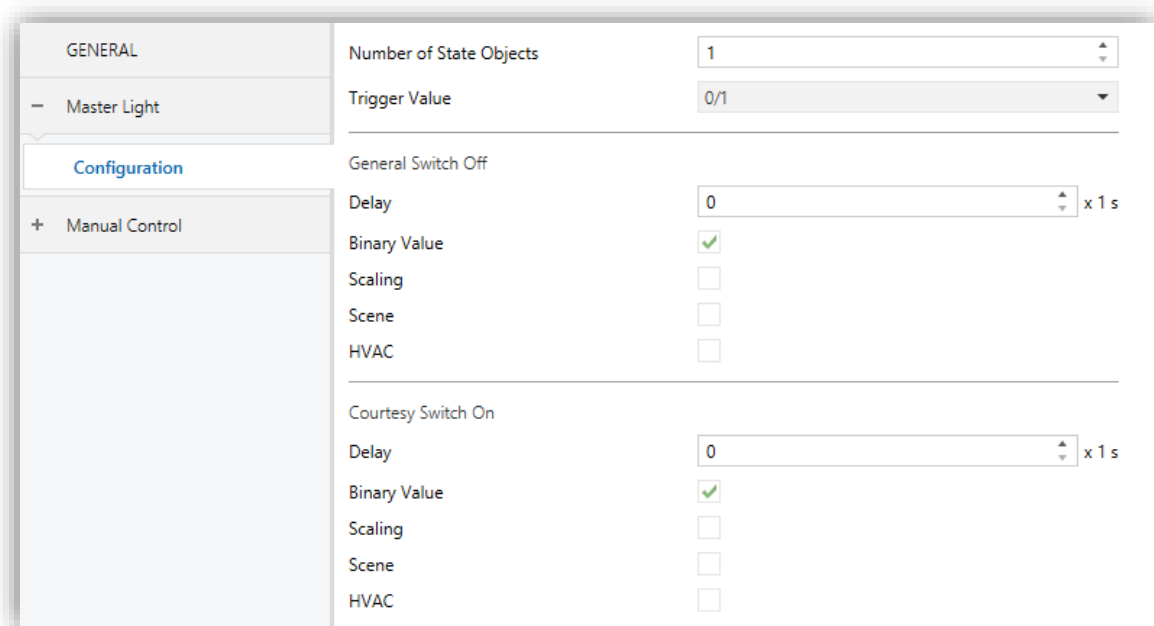

Figure 5 Master Light.

2.8 SCENE TEMPORISATION

The scene temporisation allows imposing **delays over the scenes of the outputs**. These delays are defined in parameters, and can be applied to the execution of one or more scenes that may have been configured.

Please bear in mind that, as multiple delayed scenes can be configured for each individual output / shutter channel / fan coil module, in case of receiving an order of execute one of them when a previous temporisation is still pending for that output / channel / module, such temporisation will be interrupted and only the delay and the action of the new scene will be executed.

ETS PARAMETRISATION

Prior to settings the **scene temporisation**, it is necessary to have one or more scenes configured in some of the outputs. When entering the Configuration window under “Scene Temporization”, all configured scenes will be listed, together with a few checkboxes to select which of them need to be temporised, as shown in the Figure 6.

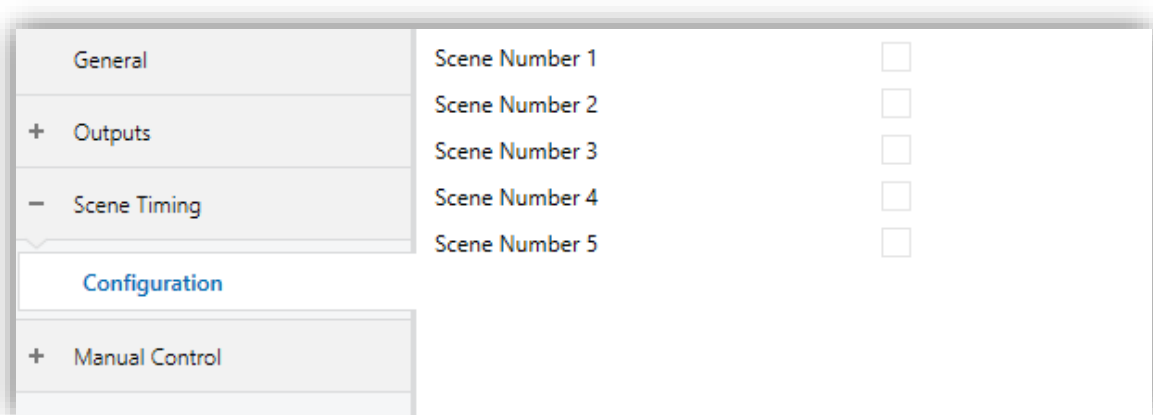

Figure 6 Scene Temporisation.

Enabling a certain scene number n brings a new tab with such name to the menu on the left, from which it is possible to configure the temporisation of that scene for each of the outputs where it has been configured.

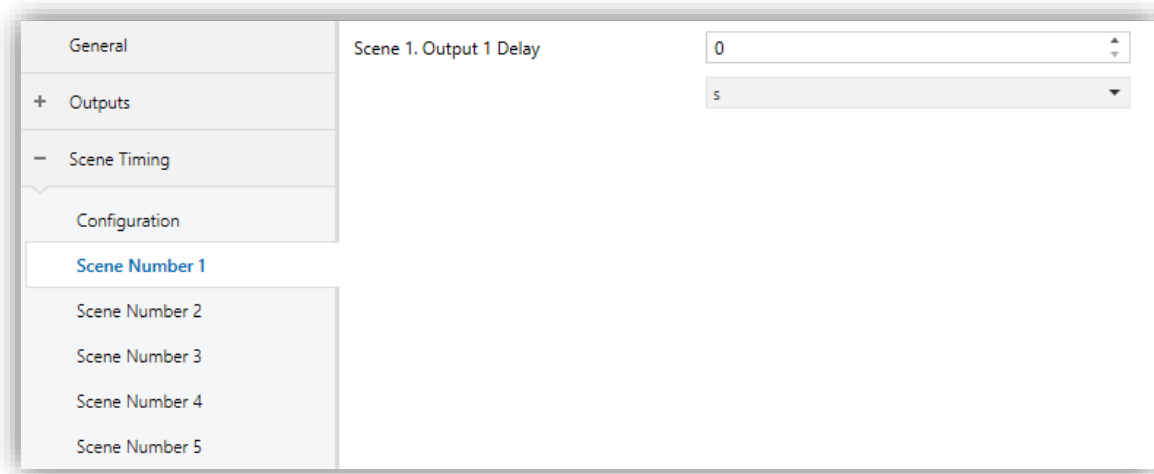

Figure 7 Scene Temporisation settings.

Therefore, parameter **Scene Y. Output X Delay** [0...3600 [s] / 0...1440 [min] / 0...24 [h]] defines the delay that will be applied to the action defined in *X* for the execution of scene *Y* (where *X* may be a specific individual output, shutter channel of fan coil module).

2.9 MANUAL CONTROL

MAXinBOX Hospitality v2 allows manually switching the state of its output relays through the respective pushbuttons on the top of the device. A specific pushbutton is therefore available per output.

Manual operation can be done in two different ways, named as **Test On Mode** (for testing purposes during the configuration of the device) and **Test Off Mode** (for a normal use, anytime). Whether both, only one, or none of these modes should be accessible needs to be parameterised in ETS. Moreover, it is possible to enable a specific binary object **for locking and unlocking the manual control** in runtime.

Notes:

- *The available control modes (Test On / Test Off) and the lock object can be enabled and disabled in MAXinBOX Hospitality v2 **independently for the relay outputs** (binary or shutter) **and for the fan coil outputs** (valves and fan).*
- *The **Test Off mode** will be active (unless it has been disabled by parameter) after a download or a reset with no need of a specific activation – the pushbuttons will respond to user presses from the start.*
- *On the contrary, switching to the **Test On mode** (unless disabled by parameter) needs to be done by long-pressing the Prog./Test button (for at least three seconds), until the LED is no longer red and turns yellow. From that moment, once the button is released, the LED light will remain green to confirm that the device has switched from the Test Off mode to the Test On mode. After that, an additional press will turn the LED yellow and then off, once the button is released. This way, the device leaves the Test On mode. Note that it will also leave this mode if a bus power failure takes place.*

This device is delivered from factory with the Test On and Test Off modes **already enabled in parameters** for all outputs.

Test Off Mode

Under the Test Off Mode, the outputs can be controlled through both their communication objects and the actual pushbuttons located on the top of the device.

When one of these buttons is pressed, the output will behave as if an order had been received through the corresponding communication object, so it has no effect if the output is locked or under alarm status. The status objects of the different functions will still be sent in the usual way.

The action performed depends on the output type.

- **Individual output:** a simple press (short or long) will make the output (if enabled in parameters) switch its on-off state. This will be reported to the KNX bus through the corresponding status object, if enabled.
- **Shutter channel:** when the button is pressed, the device will act over the output according to the length of the button press and to the current state.
 - A **long press** makes the shutter start moving (upwards or downwards, depending on the button being pressed). The LED will light in green until the end of the motion. If the button gets pressed being the shutter already at the top or bottom positions, nothing will happen (the LED will not light).
 - A **short press** will make the shutter drive stop (if in motion), as it normally does when a step/stop order is received from the KNX bus. In case of not being the shutter in motion, pressing the button does not cause any action, unless slats/lamellas have been parameterized – in such case, a step movement (up/down, depending on the button pressed) will take place. The status objects will be sent to the bus when corresponding
- **Fan:** a simple press (short or long) implies an increase or decrease of the fan speed (provided that the fan coil has been enabled in parameters), depending on the button pressed. This action will depend on the fan type (relay accumulation / relay commutation), the control type (cyclical or non-cyclical) and the minimum switch time configured. In particular:

- If the fan is already at the maximum speed level, a further increase will have no effect (in case of a non-cyclical control) or will switch back to the minimum level (in case of a cyclical control).
- If the fan is already at the minimum speed level, a further decrease will have no effect (in case of a non-cyclical control) or will switch back to the maximum level (in case of a cyclical control).
- **Valve:** a simple press (short or long) will make the valve switch its open/closed state, provided that the fan coil has been enabled in parameters. In case the fan coil control type has been configured in parameters as “applied to the fan” (instead of “applied to the valve”), this may also imply:
 - **A switch-on of the fan**, if it is found to be stopped and the valve opens, provided that the desired fan speed is other than zero.
 - **A switch-off of the fan**, if it is found to be in motion and the valve closes, provided that the current mode is Heating (under Cooling, the fan will remain as is).
- **Disabled output:** outputs disabled in parameters will not react to button presses under the Test Off mode.

Regarding the lock, timer, alarm and scene functions, the device will behave as usual under the Test Off mode. Button presses during this mode are entirely analogous to the reception of the corresponding orders from the KNX bus.

Test On Mode

After entering the Test On mode, it will only be possible to control the outputs through the on-board pushbuttons. Orders received through communication objects will be ignored, with independence of the output they are addressed to.

On the other hand, to prevent interference with the normal operation and since the Test On mode is intended for testing, once the device leaves the Test On mode it will **switch back to its previous state**.

Depending on the parameterisation of the output, the reactions to the button presses will differ.

- **Individual outputs:** short or long pressing the button will commute the on-off state of the relay.
- **Shutter channel:** pressing the button will make the shutter drive move upward or downward (depending on the button) until the button is released again, thus ignoring the position of the shutter and the parameterised times.

Note: *after leaving the Test On mode, the status objects will recover the values they had prior to entering Test On. As the device is never aware of the actual position of the shutter (as the shutter drive does not provide any feedback), these values may not show the real position. This can be solved by performing a complete move-up or move-down order, or by calibrating the shutter position in the Test On mode until it matches the status objects.*

- **Fan:** a simple press (short or long) implies an increase or decrease of the fan speed, depending on the button pressed.
 - In case the fan coil module is **disabled in parameters**, it will work as non-cyclical and through relay switching (with a 0.3 s delay).
 - In **any other case**, the Test On mode will still respect the cyclical / non-cyclical configuration, and the relay management type parameterised.
- **Valves:** a simple press (short or long) will make the valve switch its open/closed state. The behaviour is analogous as for the Test Off mode, although both valves will be controllable in Test On even if not enabled in parameters.
- **Disabled outputs:** under the Test On mode, short and long presses will cause the same effect for disabled outputs as for shutter channel outputs (i.e., the relay will switch its state until the button is released and only one relay per group is allowed to be closed).

The lock, timer, alarm and scene functions will not work while the device is under the Test On mode. Status objects will not be sent to the bus, either. However, alarms and lock orders received during the Test On mode will be taken into account once the device leaves this mode.

ETS PARAMETERISATION

The **Manual Control** is configured from a specific tab which can be enabled from the “General” screen (see section 2.1).

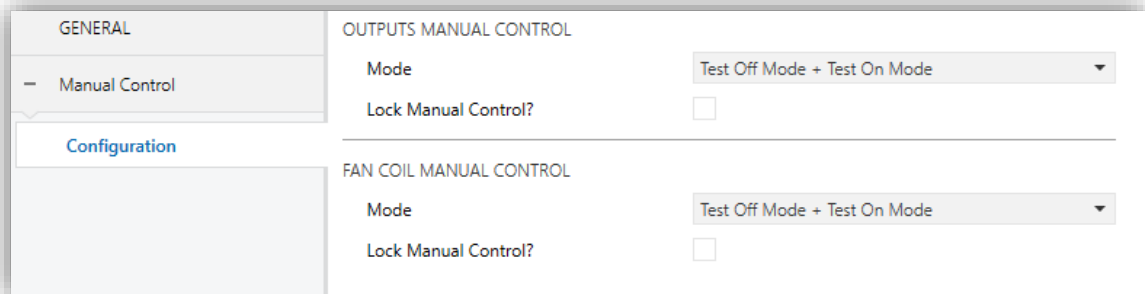

Figure 8 Manual Control.

The parameters available in this screen are grouped into two sections, as it is possible to **configure independently the behaviour of the Manual Control for both**, the *fan coil* and the individual binary outputs:

- **Mode:** options are “Disabled”, “Only Test Mode Off”, “Only Test Mode On” and “Test Mode Off + Test Mode On” (default).

Depending on the selection, the device will permit using the manual control under the Test Off, the Test On, or both modes. Note that, as stated before, using the Test Off mode does not require any special action, while switching to the Test On mode does require long-pressing the Prog./Test button.

- **Lock Manual Control:** unless the above parameter has been set to “Disabled”, enabling the Lock Manual Control parameter will provide a runtime procedure for locking the manual control. When this checkbox is enabled, object “**Manual Control Lock**” turns visible, as well as two more parameters:

- **Value:** defines whether the lock/unlock of the manual control should take place respectively upon the reception (through the aforementioned object) of values “0” and “1”, or the opposite.
- **Initialisation:** sets how the manual control should remain after the device start-up (after an ETS download or a bus power failure): “Unlocked”, “Locked” or by default, “Last Value” (unlocked after the first start-up).

ANNEX I. COMMUNICATION OBJECTS

- “**Functional range**” shows the values that, with independence of any other values permitted by the bus according to the object size, may be of any use or have a particular meaning because of the specifications or restrictions from both the KNX standard or the application program itself.

Number	Size	I/O	Flags	Data type (DPT)	Functional Range	Name	Function
1	1 Bit		C - - T -	DPT_Trigger	0/1	Reset 0	Voltage Recovery -> Sending of 0
2	1 Bit		C - - T -	DPT_Trigger	0/1	Reset 1	Voltage Recovery -> Sending of 1
3	1 Bit	I	C - W - -	DPT_Enable	0/1	Lock Manual Control (Outputs)	0 = Lock; 1 = Unlock
	1 Bit	I	C - W - -	DPT_Enable	0/1	Lock Manual Control (Outputs)	0 = Unlock; 1 = Lock
4	1 Bit	I	C - W - -	DPT_Enable	0/1	Lock Manual Control (Fan Coil)	0 = Unlock; 1 = Lock
	1 Bit	I	C - W - -	DPT_Enable	0/1	Lock Manual Control (Fan Coil)	0 = Lock; 1 = Unlock
5, 7	4 Bytes	O	C R - - -	DPT_Value_4_Ucount	0 - 4294967295	[Relay Ox] Number of Switches	Number of Switches
6, 8	2 Bytes	O	C R - - -	DPT_Value_2_Ucount	0 - 65535	[Relay Ox] Maximum Switches per Minute	Maximum Switches per Minute
9, 17	4 Bytes	O	C R - - -	DPT_Value_4_Ucount	0 - 4294967295	[Relay Vx] Number of Switches	Number of Switches
10, 18	2 Bytes	O	C R - - -	DPT_Value_2_Ucount	0 - 65535	[Relay Vx] Maximum Switches per Minute	Maximum Switches per Minute
11, 13, 15	4 Bytes	O	C R - - -	DPT_Value_4_Ucount	0 - 4294967295	[Relay Fx] Number of Switches	Number of Switches
12, 14, 16	2 Bytes	O	C R - - -	DPT_Value_2_Ucount	0 - 65535	[Relay Fx] Maximum Switches per Minute	Maximum Switches per Minute
19, 25, 31, 37, 43, 49	1 Bit	I	C - W - -	DPT_Enable	0/1	[Ix] Input Lock	0 = Unlock; 1 = Lock
20, 26, 32, 38, 44, 50	1 Bit		C - - T -	DPT_Switch	0/1	[Ix] [Short Press] 0	Sending of 0
	1 Bit		C - - T -	DPT_Switch	0/1	[Ix] [Short Press] 1	Sending of 1
	1 Bit	I	C - W T -	DPT_Switch	0/1	[Ix] [Short Press] 0/1 Switching	Switching 0/1
	1 Bit		C - - T -	DPT_UpDown	0/1	[Ix] [Short Press] Move Up Shutter	Sending of 0 (Up)
	1 Bit		C - - T -	DPT_UpDown	0/1	[Ix] [Short Press] Move Down Shutter	Sending of 1 (Down)
	1 Bit		C - - T -	DPT_UpDown	0/1	[Ix] [Short Press] Move Up/Down Shutter	Switching 0/1 (Up/Down)
	1 Bit		C - - T -	DPT_Step	0/1	[Ix] [Short Press] Stop/Step Up Shutter	Sending of 0 (Stop/Step Up)
	1 Bit		C - - T -	DPT_Step	0/1	[Ix] [Short Press] Stop/Step Down Shutter	Sending of 1 (Stop/Step Down)
	1 Bit		C - - T -	DPT_Step	0/1	[Ix] [Short Press] Stop/Step Shutter (Switched)	Switching of 0/1 (Stop/Step Up/Down)
	4 Bit		C - - T -	DPT_Control_Dimming	0x0 (Stop) 0x1 (Dec. by 100%) ... 0x7 (Dec. by 1%) 0x8 (Stop) 0xD (Inc. by 100%)	[Ix] [Short Press] Brighter	Increase Brightness

				...		
				0xF (Inc. by 1%)		
	4 Bit		C--T-	DPT_Control_Dimming	0x0 (Stop) 0x1 (Dec. by 100%) ... 0x7 (Dec. by 1%) 0x8 (Stop) 0xD (Inc. by 100%) ... 0xF (Inc. by 1%)	[Ix] [Short Press] Darker Decrease Brightness
	4 Bit		C--T-	DPT_Control_Dimming	0x0 (Stop) 0x1 (Dec. by 100%) ... 0x7 (Dec. by 1%) 0x8 (Stop) 0xD (Inc. by 100%) ... 0xF (Inc. by 1%)	[Ix] [Short Press] Brighter/Darker Switch Bright/Dark
	1 Bit		C--T-	DPT_Switch	0/1	[Ix] [Short Press] Light On Sending of 1 (On)
	1 Bit		C--T-	DPT_Switch	0/1	[Ix] [Short Press] Light Off Sending of 0 (Off)
	1 Bit	I	C-WT-	DPT_Switch	0/1	[Ix] [Short Press] Light On/Off Switching 0/1
	1 Byte		C--T-	DPT_SceneControl	0-63; 128-191	[Ix] [Short Press] Run Scene Sending of 0 - 63
	1 Byte		C--T-	DPT_SceneControl	0-63; 128-191	[Ix] [Short Press] Save Scene Sending of 128 - 191
	1 Bit	I/O	CRWT-	DPT_Switch	0/1	[Ix] [Switch/Sensor] Edge Sending of 0 or 1
	1 Byte		C--T-	DPT_Value_1_Ucount	0 - 255	[Ix] [Short Press] Constant Value (Integer) 0 - 255
	1 Byte		C--T-	DPT_Scaling	0% - 100%	[Ix] [Short Press] Constant Value (Percentage) 0% - 100%
	2 Bytes		C--T-	DPT_Value_2_Ucount	0 - 65535	[Ix] [Short Press] Constant Value (Integer) 0 - 65535
	2 Bytes		C--T-	9.xxx	-671088.64 - 670433.28	[Ix] [Short Press] Constant Value (Float) Float Value
21, 27, 33, 39, 45, 51	1 Byte	I	C-W--	DPT_Scaling	0% - 100%	[Ix] [Short Press] Shutter Status (Input) 0% = Top; 100% = Bottom
	1 Byte	I	C-W--	DPT_Scaling	0% - 100%	[Ix] [Short Press] Dimming Status (Input) 0% - 100%
22, 28, 34, 40, 46, 52	1 Bit		C--T-	DPT_Switch	0/1	[Ix] [Long Press] 0 Sending of 0
	1 Bit		C--T-	DPT_Switch	0/1	[Ix] [Long Press] 1 Sending of 1
	1 Bit	I	C-WT-	DPT_Switch	0/1	[Ix] [Long Press] 0/1 Switching Switching 0/1
	1 Bit		C--T-	DPT_UpDown	0/1	[Ix] [Long Press] Move Up Shutter Sending of 0 (Up)
	1 Bit		C--T-	DPT_UpDown	0/1	[Ix] [Long Press] Move Down Shutter Sending of 1 (Down)
	1 Bit		C--T-	DPT_UpDown	0/1	[Ix] [Long Press] Move Up/Down Shutter Switching 0/1 (Up/Down)
	1 Bit		C--T-	DPT_Step	0/1	[Ix] [Long Press] Stop/Step Up Shutter Sending of 0 (Stop/Step Up)

23, 29, 35, 41, 47, 53	1 Bit		C - - T -	DPT_Step	0/1	[Ix] [Long Press] Stop/Step Down Shutter	Sending of 1 (Stop/Step Down)
	1 Bit		C - - T -	DPT_Step	0/1	[Ix] [Long Press] Stop/Step Shutter (Switched)	Switching of 0/1 (Stop/Step Up/Down)
	4 Bit		C - - T -	DPT_Control_Dimming	0x0 (Stop) 0x1 (Dec. by 100%) ... 0x7 (Dec. by 1%) 0x8 (Stop) 0xD (Inc. by 100%) ... 0xF (Inc. by 1%)	[Ix] [Long Press] Brighter	Long Pr. -> Brighter; Release -> Stop
	4 Bit		C - - T -	DPT_Control_Dimming	0x0 (Stop) 0x1 (Dec. by 100%) ... 0x7 (Dec. by 1%) 0x8 (Stop) 0xD (Inc. by 100%) ... 0xF (Inc. by 1%)	[Ix] [Long Press] Darker	Long Pr. -> Darker; Release -> Stop
	4 Bit		C - - T -	DPT_Control_Dimming	0x0 (Stop) 0x1 (Dec. by 100%) ... 0x7 (Dec. by 1%) 0x8 (Stop) 0xD (Inc. by 100%) ... 0xF (Inc. by 1%)	[Ix] [Long Press] Brighter/Darker	Long Pr. -> Brighter/Darker; Release -> Stop
	1 Bit		C - - T -	DPT_Switch	0/1	[Ix] [Long Press] Light On	Sending of 1 (On)
	1 Bit		C - - T -	DPT_Switch	0/1	[Ix] [Long Press] Light Off	Sending of 0 (Off)
	1 Bit	I	C - W T -	DPT_Switch	0/1	[Ix] [Long Press] Light On/Off	Switching 0/1
	1 Byte		C - - T -	DPT_SceneControl	0-63; 128-191	[Ix] [Long Press] Run Scene	Sending of 0 - 63
	1 Byte		C - - T -	DPT_SceneControl	0-63; 128-191	[Ix] [Long Press] Save Scene	Sending of 128 - 191
	1 Bit	O	C R - T -	DPT_Alarm	0/1	[Ix] [Switch/Sensor] Alarm: Breakdown or Sabotage	1 = Alarm; 0 = No Alarm
	2 Bytes		C - - T -	9.xxx	-671088.64 - 670433.28	[Ix] [Long Press] Constant Value (Float)	Float Value
	2 Bytes		C - - T -	DPT_Value_2_Ucount	0 - 65535	[Ix] [Long Press] Constant Value (Integer)	0 - 65535
	1 Byte		C - - T -	DPT_Scaling	0% - 100%	[Ix] [Long Press] Constant Value (Percentage)	0% - 100%
	1 Byte		C - - T -	DPT_Value_1_Ucount	0 - 255	[Ix] [Long Press] Constant Value (Integer)	0 - 255
	1 Bit		C - - T -	DPT_Trigger	0/1	[Ix] [Long Press/Release] Stop Shutter	Release -> Stop Shutter

24, 30, 36, 42, 48, 54	1 Byte	I	C-W--	DPT_Scaling	0% - 100%	[Ix] [Long Press] Dimming Status (Input)	0% - 100%
	1 Byte	I	C-W--	DPT_Scaling	0% - 100%	[Ix] [Long Press] Shutter Status (Input)	0% = Top; 100% = Bottom
55	1 Byte	I	C-W--	DPT_SceneNumber	0 - 63	[Motion Detector] Scene Input	Scene Value
56	1 Byte		C--T-	DPT_SceneControl	0-63; 128-191	[Motion Detector] Scene Output	Scene Value
57, 86, 115, 144, 173, 202	1 Byte	O	CR-T-	DPT_Scaling	0% - 100%	[Ix] Luminosity	0-100%
58, 87, 116, 145, 174, 203	1 Bit	O	CR-T-	DPT_Alarm	0/1	[Ix] Open Circuit Error	0 = No Error; 1 = Open Circuit Error
59, 88, 117, 146, 175, 204	1 Bit	O	CR-T-	DPT_Alarm	0/1	[Ix] Short Circuit Error	0 = No Error; 1 = Short Circuit Error
60, 89, 118, 147, 176, 205	1 Byte	O	CR-T-	DPT_Scaling	0% - 100%	[Ix] Presence State (Scaling)	0-100%
61, 90, 119, 148, 177, 206	1 Byte	O	CR-T-	DPT_HVACMode	1=Comfort 2=Standby 3=Economy 4=Building Protection	[Ix] Presence State (HVAC)	Auto, Comfort, Standby, Economy, Building Protection
62, 91, 120, 149, 178, 207	1 Bit	O	CR-T-	DPT_Switch	0/1	[Ix] Presence State (Binary)	Binary Value
	1 Bit	O	CR-T-	DPT_Ack	0/1	[Ix] Presence: Slave Output	1 = Motion Detected
63, 92, 121, 150, 179, 208	1 Bit	I	C-W--	DPT_Window_Door	0/1	[Ix] Presence Trigger	Binary Value to Trigger the Presence Detection
64, 93, 122, 151, 180, 209	1 Bit	I	C-W--	DPT_Ack	0/1	[Ix] Presence: Slave Input	0 = Nothing; 1 = Detection from slave device
65, 94, 123, 152, 181, 210	2 Bytes	I	C-W--	DPT_TimePeriodSec	0 - 65535	[Ix] Presence: Waiting Time	0-65535 s.
66, 95, 124, 153, 182, 211	2 Bytes	I	C-W--	DPT_TimePeriodSec	0 - 65535	[Ix] Presence: Listening Time	1-65535 s.
67, 96, 125, 154, 183, 212	1 Bit	I	C-W--	DPT_Enable	0/1	[Ix] Presence: Enable	According to parameters
68, 97, 126, 155, 184, 213	1 Bit	I	C-W--	DPT_DayNight	0/1	[Ix] Presence: Day/Night	According to parameters
69, 98, 127, 156, 185, 214	1 Bit	O	CR-T-	DPT_Occupancy	0/1	[Ix] Presence: Occupancy State	0 = Not Occupied; 1 = Occupied
70, 99, 128, 157, 186, 215	1 Bit	I	C-W--	DPT_Ack	0/1	[Ix] External Motion Detection	0 = Nothing; 1 = Motion detected by an external sensor
71, 76, 81, 100, 105, 110, 129, 134, 139, 158, 163, 168, 187, 192, 197, 216, 221, 226	1 Byte	O	CR-T-	DPT_Scaling	0% - 100%	[Ix] [Cx] Detection State (Scaling)	0-100%
72, 77, 82, 101, 106,	1 Byte	O	CR-T-	DPT_HVACMode	1=Comfort	[Ix] [Cx] Detection State (HVAC)	Auto, Comfort, Standby, Economy,

111, 130, 135, 140, 159, 164, 169, 188, 193, 198, 217, 222, 227					2=Standby 3=Economy 4=Building Protection		Building Protection
73, 78, 83, 102, 107, 112, 131, 136, 141, 160, 165, 170, 189, 194, 199, 218, 223, 228	1 Bit	O	CR-T-	DPT_Switch	0/1	[Ix] [Cx] Detection State (Binary)	Binary Value
74, 79, 84, 103, 108, 113, 132, 137, 142, 161, 166, 171, 190, 195, 200, 219, 224, 229	1 Bit	I	C-W--	DPT_Enable	0/1	[Ix] [Cx] Enable Channel	According to parameters
75, 80, 85, 104, 109, 114, 133, 138, 143, 162, 167, 172, 191, 196, 201, 220, 225, 230	1 Bit	I	C-W--	DPT_Switch	0/1	[Ix] [Cx] Force State	0 = No Detection; 1 = Detection
231, 235, 239, 243, 247, 251	2 Bytes	O	CR-T-	DPT_Value_Temp	-273.00° - 670433.28°	[Ix] Current Temperature	Temperature Sensor Value
232, 236, 240, 244, 248, 252	1 Bit	O	CR-T-	DPT_Alarm	0/1	[Ix] Overcooling	0 = No Alarm; 1 = Alarm
233, 237, 241, 245, 249, 253	1 Bit	O	CR-T-	DPT_Alarm	0/1	[Ix] Overheating	0 = No Alarm; 1 = Alarm
234, 238, 242, 246, 250, 254	1 Bit	O	CR-T-	DPT_Alarm	0/1	[Ix] Probe Error	0 = No Alarm; 1 = Alarm
255, 266, 277	1 Byte	I	C-W--	DPT_SceneControl	0-63; 128-191	[Ox] Scenes	0 - 63 (Execute 1 - 64); 128 - 191 (Save 1 - 64)
256, 267, 278	1 Bit	I	C-W--	DPT_BinaryValue	0/1	[Ox] On/Off	N.O. (0=Open Relay; 1=Close Relay)
	1 Bit	I	C-W--	DPT_BinaryValue	0/1	[Ox] On/Off	N.C. (0=Close Relay; 1= Open Relay)
257, 268, 279	1 Bit	O	CR-T-	DPT_BinaryValue	0/1	[Ox] On/Off (Status)	0=Output Off; 1=Output On
258, 269, 280	1 Bit	I	C-W--	DPT_Enable	0/1	[Ox] Lock	0=Unlock; 1=Lock
259, 270, 281	1 Bit	I	C-W--	DPT_Start	0/1	[Ox] Timer	0=Switch Off; 1=Switch On
260, 271, 282	1 Bit	I	C-W--	DPT_Start	0/1	[Ox] Flashing	0=Stop; 1=Start
261, 272, 283	1 Bit	I	C-W--	DPT_Alarm	0/1	[Ox] Alarm	0=Normal; 1=Alarm
	1 Bit	I	C-W--	DPT_Alarm	0/1	[Ox] Alarm	0=Alarm; 1=Normal
262, 273, 284	1 Bit	I	C-W--	DPT_Ack	0/1	[Ox] Unfreeze Alarm	Alarm=0 + Unfreeze=1 => End Alarm
263, 274, 285	1 Bit	O	CR-T-	DPT_State	0/1	[Ox] Warning Time (Status)	0=Normal; 1=Warning
264, 275, 286	4 Bytes	I/O	CRWT-	DPT_LongDeltaTimeSec	-2147483648 - 2147483647	[Ox] Operating Time (s)	Time in Seconds

265, 276, 287	2 Bytes	I/O	CRWT-	DPT_TimePeriodHrs	0 - 65535	[Ox] Operating Time (h)	Time in Hours
288	1 Byte	I	C-W--	DPT_SceneControl	0-63; 128-191	[Shutter] Scenes	0 - 63 (Execute 1 - 64); 128 - 191 (Save 1 - 64)
289	1 Bit	I	C-W--	DPT_UpDown	0/1	[Cx] Move	0=Raise; 1=Lower
290	1 Bit	I	C-W--	DPT_Step	0/1	[Cx] Stop/Step	0=Stop/StepUp; 1=Stop/StepDown
	1 Bit	I	C-W--	DPT_Trigger	0/1	[Cx] Stop	0=Stop; 1=Stop
291	1 Bit	I	C-W--	DPT_Enable	0/1	[Cx] Lock	0=Unlock; 1=Lock
292	1 Byte	I	C-W--	DPT_Scaling	0% - 100%	[Cx] Shutter Positioning	0%=Top; 100%=Bottom
293	1 Byte	O	CR-T-	DPT_Scaling	0% - 100%	[Cx] Shutter Position (Status)	0%=Top; 100%=Bottom
294	1 Byte	I	C-W--	DPT_Scaling	0% - 100%	[Cx] Slats Positioning	0%=Open; 100%=Closed
295	1 Byte	O	CR-T-	DPT_Scaling	0% - 100%	[Cx] Slats Position (Status)	0%=Open; 100%=Closed
296	1 Bit	O	CR-T-	DPT_Switch	0/1	[Cx] Rising Relay (Status)	0=Open; 1=Closed
297	1 Bit	O	CR-T-	DPT_Switch	0/1	[Cx] Lowering Relay (Status)	0=Open; 1=Closed
298	1 Bit	O	CR-T-	DPT_Switch	0/1	[Cx] Movement (Status)	0=Stopped; 1=Moving
299	1 Bit	O	CR-T-	DPT_UpDown	0/1	[Cx] Movement Direction (Status)	0=Upward; 1=Downward
300	1 Bit	I	C-W--	DPT_Switch	0/1	[Cx] Auto: On/Off	0=On; 1=Off
	1 Bit	I	C-W--	DPT_Switch	0/1	[Cx] Auto: On/Off	0=Off; 1=On
301	1 Bit	O	CR-T-	DPT_Switch	0/1	[Cx] Auto: On/Off (Status)	0=On; 1=Off
	1 Bit	O	CR-T-	DPT_Switch	0/1	[Cx] Auto: On/Off (Status)	0=Off; 1=On
302	1 Bit	I	C-W--	DPT_UpDown	0/1	[Cx] Auto: Move	0=Raise; 1=Lower
303	1 Bit	I	C-W--	DPT_Step	0/1	[Cx] Auto: Stop/Step	0=Stop/StepUp; 1=Stop/StepDown
	1 Bit	I	C-W--	DPT_Step	0/1	[Cx] Auto: Stop	0=Stop; 1=Stop
304	1 Byte	I	C-W--	DPT_Scaling	0% - 100%	[Cx] Auto: Shutter Positioning	0%=Top; 100%=Bottom
305	1 Byte	I	C-W--	DPT_Scaling	0% - 100%	[Cx] Auto: Slats Positioning	0%=Open; 100%=Closed
306	1 Bit	I	C-WTU	DPT_Scene_AB	0/1	[Cx] Sunshine/Shadow	0=Sunshine; 1=Shadow
	1 Bit	I	C-WTU	DPT_Scene_AB	0/1	[Cx] Sunshine/Shadow	0=Shadow; 1=Sunshine
307	1 Bit	I	C-WTU	DPT_Heat_Cool	0/1	[Cx] Cooling/Heating	0=Heating; 1=Cooling
	1 Bit	I	C-WTU	DPT_Heat_Cool	0/1	[Cx] Cooling/Heating	0=Cooling; 1=Heating
308	1 Bit	I	C-WTU	DPT_Occupancy	0/1	[Cx] Presence/No Presence	0=Presence; 1=No Presence
	1 Bit	I	C-WTU	DPT_Occupancy	0/1	[Cx] Presence/No Presence	0=No Presence; 1=Presence
309, 310	1 Bit	I	C-W--	DPT_Alarm	0/1	[Cx] Alarm x	0=No Alarm; 1=Alarm
	1 Bit	I	C-W--	DPT_Alarm	0/1	[Cx] Alarm x	0=Alarm; 1=No Alarm
311	1 Bit	I	C-W--	DPT_Ack	0/1	[Cx] Unfreeze Alarm	Alarm1=Alarm2=No Alarm + Unfreeze (1) => End Alarm
312	1 Bit	I	C-W--	DPT_Scene_AB	0/1	[Cx] Move (Reversed)	0=Lower; 1=Raise
313	1 Bit	I	C-W--	DPT_Ack	0/1	[Cx] Direct Positioning 1	0=No Action; 1=Go to Position
314	1 Bit	I	C-W--	DPT_Ack	0/1	[Cx] Direct Positioning 2	0=No Action; 1=Go to Position

315	1 Bit	I	C - W - -	DPT_Ack	0/1	[Cx] Direct Positioning 1 (Save)	0=No Action; 1=Save Current Position
316	1 Bit	I	C - W - -	DPT_Ack	0/1	[Cx] Direct Positioning 2 (Save)	0=No Action; 1=Save Current Position
317, 318, 319, 320, 321, 322, 323, 324, 325, 326, 327, 328, 329, 330, 331, 332, 333, 334, 335, 336, 337, 338, 339, 340, 341, 342, 343, 344, 345, 346, 347, 348	1 Bit	I	C - W - -	DPT_Bool	0/1	[LF] (1-Bit) Data Entry x	Binary Data Entry (0/1)
349, 350, 351, 352, 353, 354, 355, 356, 357, 358, 359, 360, 361, 362, 363, 364	1 Byte	I	C - W - -	DPT_Value_1_Ucount	0 - 255	[LF] (1-Byte) Data Entry x	1-Byte Data Entry (0-255)
365, 366, 367, 368, 369, 370, 371, 372, 373, 374, 375, 376, 377, 378, 379, 380	2 Bytes	I	C - W - -	1.xxx	0/1	[LF] (2-Byte) Data Entry x	2-Byte Data Entry
381, 382, 383, 384, 385, 386, 387, 388	4 Bytes	I	C - W - -	DPT_Value_4_Count	-2147483648 - 2147483647	[LF] (4-Byte) Data Entry x	4-Byte Data Entry
389, 390, 391, 392, 393, 394, 395, 396, 397, 398	1 Bit	O	CR - T -	DPT_Bool	0/1	[LF] Function x - Result	(1-Bit) Boolean
	1 Byte	O	CR - T -	DPT_Value_1_Ucount	0 - 255	[LF] Function x - Result	(1-Byte) Unsigned
	2 Bytes	O	CR - T -	DPT_Value_2_Ucount	0 - 65535	[LF] Function x - Result	(2-Byte) Unsigned
	4 Bytes	O	CR - T -	DPT_Value_4_Count	-2147483648 - 2147483647	[LF] Function x - Result	(4-Byte) Signed
	1 Byte	O	CR - T -	DPT_Scaling	0% - 100%	[LF] Function x - Result	(1-Byte) Percentage
	2 Bytes	O	CR - T -	DPT_Value_2_Count	-32768 - 32767	[LF] Function x - Result	(2-Byte) Signed
	2 Bytes	O	CR - T -	DPT_Value_Temp	-273.00° - 670433.28°	[LF] Function x - Result	(2-Byte) Float
399	1 Byte	I	C - W - U	DPT_SceneControl	0-63; 128-191	[Fan Coil] Scenes	0 - 63 (Execute 1 - 64); 128 - 191 (Save 1 - 64)
400	1 Bit	I	C - W - U	DPT_Switch	0/1	[FCx] On/Off	0 = Off; 1 = On
401	1 Bit	O	CR - T -	DPT_Switch	0/1	[FCx] On/Off (Status)	0 = Off; 1 = On
402	1 Bit	I	C - W - U	DPT_Heat_Cool	0/1	[FCx] Mode	0 = Cool; 1 = Heat
403	1 Bit	O	CR - T -	DPT_Heat_Cool	0/1	[FCx] Mode (Status)	0 = Cool; 1 = Heat
404	1 Bit	I	C - W - U	DPT_Switch	0/1	[FCx] Fan: Manual/Automatic	0 = Automatic; 1 = Manual
	1 Bit	I	C - W - U	DPT_Switch	0/1	[FCx] Fan: Manual/Automatic	0 = Manual; 1 = Automatic
405	1 Bit	O	CR - T -	DPT_Switch	0/1	[FCx] Fan: Manual/Automatic (Status)	0 = Automatic; 1 = Manual
	1 Bit	O	CR - T -	DPT_Switch	0/1	[FCx] Fan: Manual/Automatic (Status)	0 = Manual; 1 = Automatic
406	1 Bit	I	C - W - U	DPT_Step	0/1	[FCx] Manual Fan: Step Control	0 = Down; 1 = Up

407	1 Bit	I	C - W - U	DPT_Switch	0/1	[FCx] Manual Fan: Speed 0	0 = Off; 1 = On
408	1 Bit	I	C - W - U	DPT_Switch	0/1	[FCx] Manual Fan: Speed 1	0 = Off; 1 = On
409	1 Bit	I	C - W - U	DPT_Switch	0/1	[FCx] Manual Fan: Speed 2	0 = Off; 1 = On
410	1 Bit	I	C - W - U	DPT_Switch	0/1	[FCx] Manual Fan: Speed 3	0 = Off; 1 = On
411	1 Bit	O	CR - T -	DPT_Switch	0/1	[FCx] Fan: Speed 0 (Status)	0 = Off; 1 = On
412	1 Bit	O	CR - T -	DPT_Switch	0/1	[FCx] Fan: Speed 1 (Status)	0 = Off; 1 = On
413	1 Bit	O	CR - T -	DPT_Switch	0/1	[FCx] Fan: Speed 2 (Status)	0 = Off; 1 = On
414	1 Bit	O	CR - T -	DPT_Switch	0/1	[FCx] Fan: Speed 3 (Status)	0 = Off; 1 = On
415	1 Byte	I	C - W - U	DPT_Fan_Stage	0 - 255	[FCx] Manual Fan: Enumeration Control	S0 = 0; S1 = 1; S2 = 2; S3 = 3
	1 Byte	I	C - W - U	DPT_Fan_Stage	0 - 255	[FCx] Manual Fan: Enumeration Control	S0 = 0; S1 = 1; S2 = 2
	1 Byte	I	C - W - U	DPT_Fan_Stage	0 - 255	[FCx] Manual Fan: Enumeration Control	S0 = 0; S1 = 1
416	1 Byte	O	CR - T -	DPT_Fan_Stage	0 - 255	[FCx] Fan: Speed Enumeration (Status)	S0 = 0; S1 = 1; S2 = 2; S3 = 3
	1 Byte	O	CR - T -	DPT_Fan_Stage	0 - 255	[FCx] Fan: Speed Enumeration (Status)	S0 = 0; S1 = 1; S2 = 2
	1 Byte	O	CR - T -	DPT_Fan_Stage	0 - 255	[FCx] Fan: Speed Enumeration (Status)	S0 = 0; S1 = 1
417	1 Byte	I	C - W - U	DPT_Scaling	0% - 100%	[FCx] Manual Fan: Percentage Control	S0 = 0%; S1 = 0,4-33,3%; S2 = 33,7-66,7%; S3 = 67,1-100%
	1 Byte	I	C - W - U	DPT_Scaling	0% - 100%	[FCx] Manual Fan: Percentage Control	S0 = 0%; S1 = 1-50%; S2 = 51-100%
	1 Byte	I	C - W - U	DPT_Scaling	0% - 100%	[FCx] Manual Fan: Percentage Control	S0 = 0%; S1 = 1-100%
418	1 Byte	O	CR - T -	DPT_Scaling	0% - 100%	[FCx] Fan: Speed Percentage (Status)	S0 = 0%; S1 = 33,3%; S2 = 66,6%; S3 = 100%
	1 Byte	O	CR - T -	DPT_Scaling	0% - 100%	[FCx] Fan: Speed Percentage (Status)	S0 = 0%; S1 = 1-50%; S2 = 51-100%
	1 Byte	O	CR - T -	DPT_Scaling	0% - 100%	[FCx] Fan: Speed Percentage (Status)	S0 = 0%; S1 = 1-100%
419	1 Byte	I	C - W - U	DPT_Scaling	0% - 100%	[FCx] Cooling Fan: Continuous Control	0 - 100%
	1 Byte	I	C - W - U	DPT_Scaling	0% - 100%	[FCx] Cooling Valve: PI Control (Continuous)	0 - 100%
420	1 Byte	I	C - W - U	DPT_Scaling	0% - 100%	[FCx] Heating Fan: Continuous Control	0 - 100%
	1 Byte	I	C - W - U	DPT_Scaling	0% - 100%	[FCx] Heating Valve: PI Control (Continuous)	0 - 100%
421	1 Bit	I	C - W - U	DPT_OpenClose	0/1	[FCx] Cooling Valve: Control Variable (1 bit)	0 = Open Valve; 1 = Close Valve
	1 Bit	I	C - W - U	DPT_Switch	0/1	[FCx] Cooling Valve: Control Variable (1 bit)	0 = Close Valve; 1 = Open Valve
422	1 Bit	I	C - W - U	DPT_OpenClose	0/1	[FCx] Heating Valve: Control Variable (1 bit)	0 = Open Valve; 1 = Close Valve
	1 Bit	I	C - W - U	DPT_Switch	0/1	[FCx] Heating Valve: Control Variable (1 bit)	0 = Close Valve; 1 = Open Valve
423	1 Bit	O	CR - T -	DPT_OpenClose	0/1	[FCx] Cooling Valve (Status)	0 = Open; 1 = Closed
	1 Bit	O	CR - T -	DPT_Switch	0/1	[FCx] Cooling Valve (Status)	0 = Closed; 1 = Open
	1 Bit	O	CR - T -	DPT_OpenClose	0/1	[FCx] Valve (Status)	0 = Open; 1 = Closed
	1 Bit	O	CR - T -	DPT_Switch	0/1	[FCx] Valve (Status)	0 = Closed; 1 = Open
424	1 Bit	O	CR - T -	DPT_OpenClose	0/1	[FCx] Heating Valve (Status)	0 = Open; 1 = Closed
	1 Bit	O	CR - T -	DPT_Switch	0/1	[FCx] Heating Valve (Status)	0 = Closed; 1 = Open
425	1 Bit	O	CR - T -	DPT_Switch	0/1	[FCx] Cooling Valve: Anti-Seize Protection	0 = Not Active; 1 = Active

						(Status)	
	1 Bit	O	CR-T-	DPT_Switch	0/1	[FCx] Valve: Anti-Seize Protection (Status)	0 = Not Active; 1 = Active
426	1 Bit	O	CR-T-	DPT_Switch	0/1	[FCx] Heating Valve: Anti-Seize Protection (Status)	0 = Not Active; 1 = Active
427	1 Byte	O	CR-T-	DPT_Scaling	0% - 100%	[FCx] Valve (Status)	0 - 100%
	1 Byte	O	CR-T-	DPT_Scaling	0% - 100%	[FCx] Cooling Valve (Status)	0 - 100%
428	1 Byte	O	CR-T-	DPT_Scaling	0% - 100%	[FCx] Heating Valve (Status)	0 - 100%
429	1 Bit	O	CR-T-	DPT_Bool	0/1	[FCx] Control Value - Error	0 = No Error; 1 = Error
430	2 Bytes	I	C-W-U	DPT_Value_Temp	-273.00° - 670433.28°	[FCx] Ambient Temperature	Ambient Temperature
431	2 Bytes	I	C-W-U	DPT_Value_Temp	-273.00° - 670433.28°	[FCx] Setpoint Temperature	Setpoint Temperature
432	2 Bytes	I/O	CRWTU	DPT_TimePeriodMin	0 - 65535	[FCx] Duration of Manual Control	0 = Endless; 1 - 1440 min
	2 Bytes	I/O	CRWTU	DPT_TimePeriodHrs	0 - 65535	[FCx] Duration of Manual Control	0 = Endless; 1 - 24 h
433, 501	1 Bit	I	C-W--	DPT_Switch	0/1	[HTx] [A] On/Off	0 = Off; 1 = On
434, 502	1 Bit	O	CR-T-	DPT_Switch	0/1	[HTx] [A] On/Off Status	0 = Off; 1 = On
435, 503	1 Byte	I	C-W--	DPT_SceneControl	0-63; 128-191	[HTx] [A] Scene Input	Scene Value
436, 504	2 Bytes	I	C-W--	DPT_Value_Temp	-273.00° - 670433.28°	[HTx] [A] Temperature Source 1	External Sensor Temperature
437, 505	2 Bytes	I	C-W--	DPT_Value_Temp	-273.00° - 670433.28°	[HTx] [A] Temperature Source 2	External Sensor Temperature
438, 506	2 Bytes	O	CR-T-	DPT_Value_Temp	-273.00° - 670433.28°	[HTx] [A] Room Temperature	Current Temperature
439, 507	1 Bit	I/O	CRW--	DPT_Heat_Cool	0/1	[HTx] [A] System Mode	0 = Cooling; 1 = Heating
440, 508	1 Bit	I/O	CRW--	DPT_Heat_Cool	0/1	[HTx] [A] User Mode	0 = Cooling; 1 = Heating
441, 509	1 Bit	I/O	CRW--	DPT_Switch	0/1	[HTx] [A] Force System Mode	0 = User Mode / Auto Change; 1 = System Mode
442, 510	1 Bit	O	CR-T-	DPT_Heat_Cool	0/1	[HTx] [A] Mode Status	0 = Cooling; 1 = Heating
443, 511	1 Byte	I	C-WTU	DPT_Scaling	0% - 100%	[HTx] [A] Fan Speed	0% - 100%
444, 512	1 Bit	I	C-WTU	DPT_Switch	0/1	[HTx] [A] Fan: Manual/Automatic	0 = Manual; 1 = Automatic
	1 Bit	I	C-WTU	DPT_Switch	0/1	[HTx] [A] Fan: Manual/Automatic	0 = Automatic; 1 = Manual
445, 513	1 Bit	O	CR-T-	DPT_Switch	0/1	[HTx] [A] On/Off Fancoil	0 = Off; 1 = On
446, 514	1 Bit	I	C-W--	DPT_Reset	0/1	[HTx] [B] User Comfort Setpoint Reset	0 = Nothing; 1 = Reset
447, 515	2 Bytes	I	C-WTU	DPT_Value_Temp	-273.00° - 670433.28°	[HTx] [B] User Setpoint Control	[-20°C, 100°C]
	2 Bytes	I	C-WTU	DPT_Value_Tempd	-670760.00° - 670433.28°	[HTx] [B] User Setpoint Offset	[-15°C, 15°C]
448, 516	1 Bit	I	C-W--	DPT_Step	0/1	[HTx] [B] Step User Setpoint	0 = Decrease; 1 = Increase
449, 517	2 Bytes	I/O	CRWTU	DPT_Value_Temp	-273.00° -	[HTx] [B] Comfort Setpoint (Cooling)	[-20°C, 100°C]

					670433.28°		
	2 Bytes	I/O	CRWTU	DPT_Value_Temp	-273.00° - 670433.28°	[HTx] [B] Comfort Setpoint	[-20°C, 100°C]
450, 518	2 Bytes	I/O	CRWTU	DPT_Value_Temp	-273.00° - 670433.28°	[HTx] [B] Standby Setpoint (Cooling)	[-20°C, 100°C]
451, 519	2 Bytes	I/O	CRWTU	DPT_Value_Temp	-273.00° - 670433.28°	[HTx] [B] Economy Setpoint (Cooling)	[-20°C, 100°C]
452, 520	2 Bytes	I/O	CRWTU	DPT_Value_Temp	-273.00° - 670433.28°	[HTx] [B] Protection Setpoint (Cooling)	[-20°C, 100°C]
453, 521	2 Bytes	I/O	CRWTU	DPT_Value_Temp	-273.00° - 670433.28°	[HTx] [B] Comfort Setpoint (Heating)	[-20°C, 100°C]
454, 522	2 Bytes	I/O	CRWTU	DPT_Value_Temp	-273.00° - 670433.28°	[HTx] [B] Standby Setpoint (Heating)	[-20°C, 100°C]
455, 523	2 Bytes	I/O	CRWTU	DPT_Value_Temp	-273.00° - 670433.28°	[HTx] [B] Economy Setpoint (Heating)	[-20°C, 100°C]
456, 524	2 Bytes	I/O	CRWTU	DPT_Value_Temp	-273.00° - 670433.28°	[HTx] [B] Protection Setpoint (Heating)	[-20°C, 100°C]
457, 525	2 Bytes	O	CR-T-	DPT_Value_Temp	-273.00° - 670433.28°	[HTx] [B] Real Setpoint Status	[-20°C, 100°C]
458, 526	2 Bytes	O	CR-T-	DPT_Value_Temp	-273.00° - 670433.28°	[HTx] [B] User Setpoint Status	[-20°C, 100°C]
	2 Bytes	O	CR-T-	DPT_Value_Tempd	-670760.00° - 670433.28°	[HTx] [B] User Setpoint Offset Status	[-15°C, 15°C]
459, 527	2 Bytes	I/O	CRWTU	DPT_TimePeriodSec	0 - 65535	[HTx] [C] Transition Time: Comfort to Default Mode	Seconds (0 = Disabled)
	2 Bytes	I/O	CRWTU	DPT_TimePeriodMin	0 - 65535	[HTx] [C] Transition Time: Comfort to Default Mode	Minutes (0 = Disabled)
	2 Bytes	I/O	CRWTU	DPT_TimePeriodHrs	0 - 65535	[HTx] [C] Transition Time: Comfort to Default Mode	Hours (0 = Disabled)
460, 528	2 Bytes	I/O	CRWTU	DPT_TimePeriodSec	0 - 65535	[HTx] [C] Transition Time: Standby to Economy	Seconds (0 = Disabled)
	2 Bytes	I/O	CRWTU	DPT_TimePeriodMin	0 - 65535	[HTx] [C] Transition Time: Standby to Economy	Minutes (0 = Disabled)
	2 Bytes	I/O	CRWTU	DPT_TimePeriodHrs	0 - 65535	[HTx] [C] Transition Time: Standby to Economy	Hours (0 = Disabled)
461, 529	2 Bytes	I/O	CRWTU	DPT_TimePeriodSec	0 - 65535	[HTx] [C] Comfort Setpoint Reset Time	Seconds (0 = Disabled)
	2 Bytes	I/O	CRWTU	DPT_TimePeriodMin	0 - 65535	[HTx] [C] Comfort Setpoint Reset Time	Minutes (0 = Disabled)
	2 Bytes	I/O	CRWTU	DPT_TimePeriodHrs	0 - 65535	[HTx] [C] Comfort Setpoint Reset Time	Hours (0 = Disabled)
462, 530	1 Bit	I/O	CRW--	DPT_Occupancy	0/1	[HTx] [C] Presence Detector (Input)	0 = Not Occupied; 1 = Occupied
463, 531	1 Bit	I/O	CRW--	DPT_Enable	0/1	[HTx] [C] Lock Presence Detection	0 = Unlocked; 1 = Locked
	1 Bit	I/O	CRW--	DPT_Enable	0/1	[HTx] [C] Lock Presence Detection	0 = Locked; 1 = Unlocked
464, 532	1 Bit	I/O	CRW--	DPT_Boot	0/1	[HTx] [C] Sold/Unsold Room (Input)	0 = Unsold; 1 = Sold
465, 533	1 Byte	I	C-W--	DPT_HVACMode	1=Comfort	[HTx] [D] Special Mode	1-byte HVAC Mode

					2=Standby 3=Economy 4=Building Protection		
466, 534	1 Bit	I	C-W--	DPT_Ack	0/1	[HTx] [D] Special Mode: Comfort	0 = Nothing; 1 = Trigger
	1 Bit	I	C-W--	DPT_Switch	0/1	[HTx] [D] Special Mode: Comfort	0 = Off; 1 = On
467, 535	1 Bit	I	C-W--	DPT_Ack	0/1	[HTx] [D] Special Mode: Standby	0 = Nothing; 1 = Trigger
	1 Bit	I	C-W--	DPT_Switch	0/1	[HTx] [D] Special Mode: Standby	0 = Off; 1 = On
468, 536	1 Bit	I	C-W--	DPT_Ack	0/1	[HTx] [D] Special Mode: Economy	0 = Nothing; 1 = Trigger
	1 Bit	I	C-W--	DPT_Switch	0/1	[HTx] [D] Special Mode: Economy	0 = Off; 1 = On
469, 537	1 Bit	I	C-W--	DPT_Ack	0/1	[HTx] [D] Special Mode: Protection	0 = Nothing; 1 = Trigger
	1 Bit	I	C-W--	DPT_Switch	0/1	[HTx] [D] Special Mode: Protection	0 = Off; 1 = On
470, 538	1 Byte	O	CR-T-	DPT_HVACMode	1=Comfort 2=Standby 3=Economy 4=Building Protection	[HTx] [D] Special Mode Status	1-byte HVAC Mode
471, 539	1 Bit	O	CR-T-	DPT_Switch	0/1	[HTx] [D] Comfort Mode Status	0 = Off; 1 = On
472, 540	1 Bit	I	C-W--	DPT_Window_Door	0/1	[HTx] [D] Window Status 1 (Input)	0 = Closed; 1 = Open
	1 Bit	I	C-W--	DPT_Window_Door	0/1	[HTx] [D] Window Status 1 (Input)	0 = Open; 1 = Closed
473, 541	1 Bit	I	C-W--	DPT_Window_Door	0/1	[HTx] [D] Window Status 2 (Input)	0 = Closed; 1 = Open
	1 Bit	I	C-W--	DPT_Window_Door	0/1	[HTx] [D] Window Status 2 (Input)	0 = Open; 1 = Closed
474, 542	1 Bit	I	C-W--	DPT_Window_Door	0/1	[HTx] [D] Window Status 3 (Input)	0 = Closed; 1 = Open
	1 Bit	I	C-W--	DPT_Window_Door	0/1	[HTx] [D] Window Status 3 (Input)	0 = Open; 1 = Closed
475, 543	1 Bit	I	C-W--	DPT_Window_Door	0/1	[HTx] [D] Window Status 4 (Input)	0 = Closed; 1 = Open
	1 Bit	I	C-W--	DPT_Window_Door	0/1	[HTx] [D] Window Status 4 (Input)	0 = Open; 1 = Closed
476, 544	1 Bit	I/O	CRW--	DPT_Enable	0/1	[HTx] [D] Enable Window Status	0 = Disabled; 1 = Enabled
477, 545	1 Bit	I/O	CRW--	DPT_Enable	0/1	[HTx] [D] Thermostat Lock	0 = Locked; 1 = Unlocked
	1 Bit	I/O	CRW--	DPT_Enable	0/1	[HTx] [D] Thermostat Lock	0 = Unlocked; 1 = Locked
478, 546	2 Bytes	I/O	CRWTU	DPT_Value_Temp	-273.00° - 670433.28°	[HTx] [D] Comfort Lower Limit	[-20°C, 100°C]
479, 547	2 Bytes	I/O	CRWTU	DPT_Value_Temp	-273.00° - 670433.28°	[HTx] [D] Comfort Upper Limit	[-20°C, 100°C]
480, 548	1 Bit	I/O	CRW--	DPT_Switch	0/1	[HTx] [D] Hidden Offset On/Off	0 = Off; 1 = On
481, 549	2 Bytes	I/O	CRWTU	DPT_Value_Tempd	-670760.00° - 670433.28°	[HTx] [D] Hidden Offset Value	[-20°C, 100°C]
482, 550	1 Bit	O	CR-T-	DPT_Bool	0/1	[HTx] [D] Eco Mode Notification	0 = Out of eco range; 1 = Setpoint in Eco Range
483, 551	1 Byte	O	CR-T-	DPT_Scaling	0% - 100%	[HTx] [D] Eco Mode Ratio	Percentage of Time Working in Eco

							Range
484, 552	2 Bytes	I/O	CRWTU	DPT_Value_Temp	-273.00° - 670433.28°	[HTx] [D] Eco Mode: Lower Limit (Cooling)	Lower Value for the Ecological Range
485, 553	2 Bytes	I/O	CRWTU	DPT_Value_Temp	-273.00° - 670433.28°	[HTx] [D] Eco Mode: Upper Limit (Heating)	Upper Value for the Ecological Range
486, 554	2 Bytes	O	CR-T-	DPT_Value_Temp	-273.00° - 670433.28°	[HTx] [D] Setpoint to Split	[-20°C, 100°C]
487, 555	2 Bytes	I	C-W--	DPT_Value_Humidity	-12% - 12%	[HTx] [F] Current Humidity	Humidity Sensor Value
488, 556	2 Bytes	I/O	CRWTU	DPT_Value_Humidity	-12% - 12%	[HTx] [F] High Humidity Alarm Threshold	Value of High Humidity Alarm Threshold
489, 557	1 Bit	I/O	CRWTU	DPT_Enable	0/1	[HTx] [F] Dehumidification Control	0 = Disabled; 1 = Enabled
490, 558	1 Bit	O	CR-T-	DPT_Bool	0/1	[HTx] [F] Dehumidification Status	0 = No Dehumidifying; 1 = Dehumidifying
491, 559	1 Bit	O	CR-T-	DPT_Alarm	0/1	[HTx] [F] High Humidity	0 = No Alarm; 1 = Alarm
492, 560	1 Bit	I/O	CRWTU	DPT_Enable	0/1	[HTx] [F] Enable Apparent Temperature	0 = Room Temperature; 1 = Apparent Temperature
493, 561	1 Byte	O	CR-T-	DPT_Scaling	0% - 100%	[HTx] [Cooling] Control Variable	PI Control (Continuous)
494, 562	1 Byte	O	CR-T-	DPT_Scaling	0% - 100%	[HTx] [Heating] Control Variable	PI Control (Continuous)
495, 563	1 Bit	O	CR-T-	DPT_Switch	0/1	[HTx] [Cooling] Control Variable	2-Point Control
	1 Bit	O	CR-T-	DPT_Switch	0/1	[HTx] [Cooling] Control Variable	PI Control (PWM)
496, 564	1 Bit	O	CR-T-	DPT_Switch	0/1	[HTx] [Heating] Control Variable	2-Point Control
	1 Bit	O	CR-T-	DPT_Switch	0/1	[HTx] [Heating] Control Variable	PI Control (PWM)
497, 565	1 Bit	O	CR-T-	DPT_Switch	0/1	[HTx] [Cooling] Additional Cool	Temp >= (Setpoint+Band) => "1"
498, 566	1 Bit	O	CR-T-	DPT_Switch	0/1	[HTx] [Heating] Additional Heat	Temp <= (Setpoint-Band) => "1"
499, 567	1 Bit	O	CR-T-	DPT_Switch	0/1	[HTx] [Cooling] PI State	0 = PI Signal 0%; 1 = PI Signal Greater than 0%
500, 568	1 Bit	O	CR-T-	DPT_Switch	0/1	[HTx] [Heating] PI State	0 = PI Signal 0%; 1 = PI Signal Greater than 0%
569	1 Bit	I	C-W--	DPT_Switch	0/1	[ML] Trigger	Trigger the Master Light Function
570, 571, 572, 573, 574, 575, 576, 577, 578, 579, 580, 581	1 Bit	I	C-W--	DPT_Switch	0/1	[ML] Status Object x	Binary Status
582	1 Bit	O	CR-T-	DPT_Switch	0/1	[ML] General Status	Binary Status
583	1 Bit		C--T-	DPT_Switch	0/1	[ML] General Switch Off: Binary Object	Switch Off Sending
584	1 Byte		C--T-	DPT_Scaling	0% - 100%	[ML] General Switch Off: Scaling	0-100%
585	1 Byte		C--T-	DPT_SceneControl	0-63; 128-191	[ML] General Switch Off: Scene	Scene Sending
586	1 Byte		C--T-	DPT_HVACMode	1=Comfort 2=Standby 3=Economy 4=Building	[ML] General Switch Off: HVAC mode	Auto, Comfort, Standby, Economy, Building Protection

					Protection		
587	1 Bit		C - - T -	DPT_Switch	0/1	[ML] Courtesy Switch On: Binary Object	Switch On Sending
588	1 Byte		C - - T -	DPT_Scaling	0% - 100%	[ML] Courtesy Switch On: Scaling	0-100%
589	1 Byte		C - - T -	DPT_SceneControl	0-63; 128-191	[ML] Courtesy Switch On: Scene	Scene Sending
590	1 Byte		C - - T -	DPT_HVACMode	1=Comfort 2=Standby 3=Economy 4=Building Protection	[ML] Courtesy Switch On: HVAC mode	Auto, Comfort, Standby, Economy, Building Protection
591	1 Bit		C - - T -	DPT_Trigger	0/1	[Heartbeat] Object to Send '1'	Sending of '1' Periodically

Join and send us your inquiries
about Zennio devices:
<http://support.zennio.com>

Zennio Avance y Tecnología S.L.
C/ Río Jarama, 132. Nave P-8.11
45007 Toledo. Spain

Tel. +34 925 232 002.

www.zennio.com
info@zennio.com



RoHS